

## PRODUCT DATA SHEET

# Distribution box with side connection

VCB125-6, VCB160-6, VCB160-6/90

NOVELTY  
SYSTEM **Ø90**



The Awenta PRO distribution box allows for the connection of up to 6 Ø75-90 ventilation ducts.

As with the other distribution boxes in the VCB series, unused spigots can be covered with plugs with gaskets included with the product. The box is characterised by a side connection available in two variants with a diameter of Ø160 mm and Ø125 mm.

Distribution boxes with side connections are ideal for installation above suspended ceilings and wherever installation height is limited.

The suitably profiled shape of the Awenta PRO boxes allows for a quiet air flow, while ensuring low pressure loss.

AWENTA PRO boxes are a well-thought-out design for long-term use. Thanks to their structure and the use of high-quality plastics and bacteriostatic additives, they will meet the expectations of the most demanding users.



VCB125-6

VCB160-6

VCB160-6/90



## AIR FLOW CHARACTERISTICS

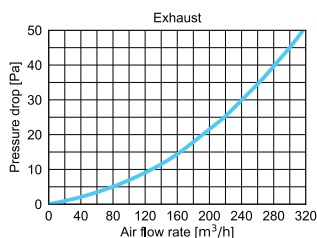
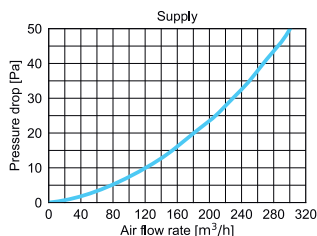
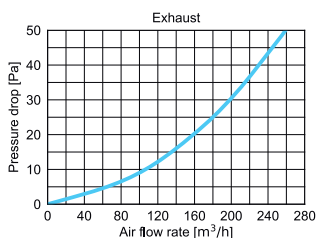
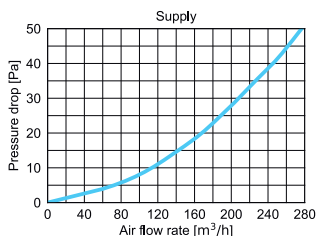
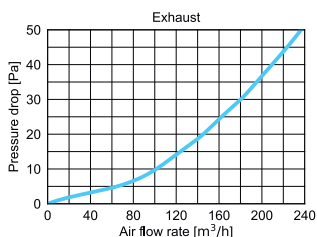
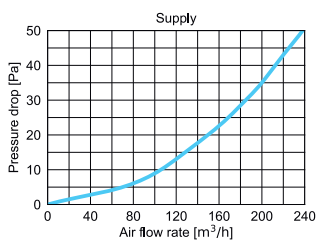

## DIMENSION

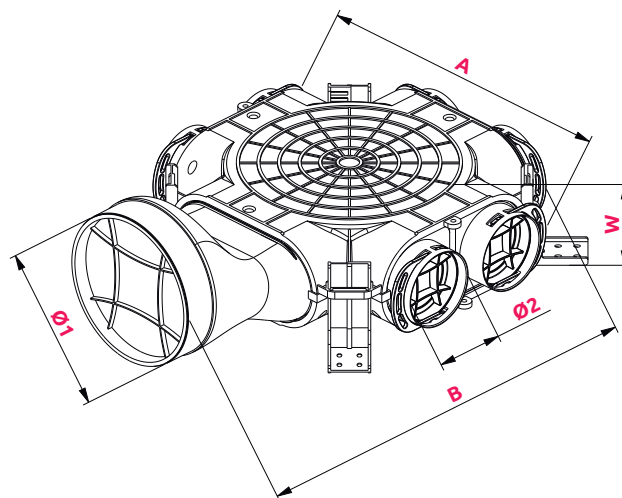

	Ø1	Ø2	A	B	W
VCB125-6	125	75	347	445	104
VCB160-6	160	75	347	475	104
VCB160-6/90	160	90	407	505	104

WITH **NANOSILVER** ADDITIVE  
ELIMINATING UP TO **99%** BACTERIA

